

Contents	
1.- DCT4 Common Baseband Schematic	7.- Bluetooth and Flash memory
2.- System connector	8.- User Interface
3.- Audio Interface	9.- RF / Power Amplifier
4.- Dual Power Management	10.- Layout/Measurement points
5.- UPP 8M Implementation	11.- Component finder
6.- GSM RF Baseband Interface	

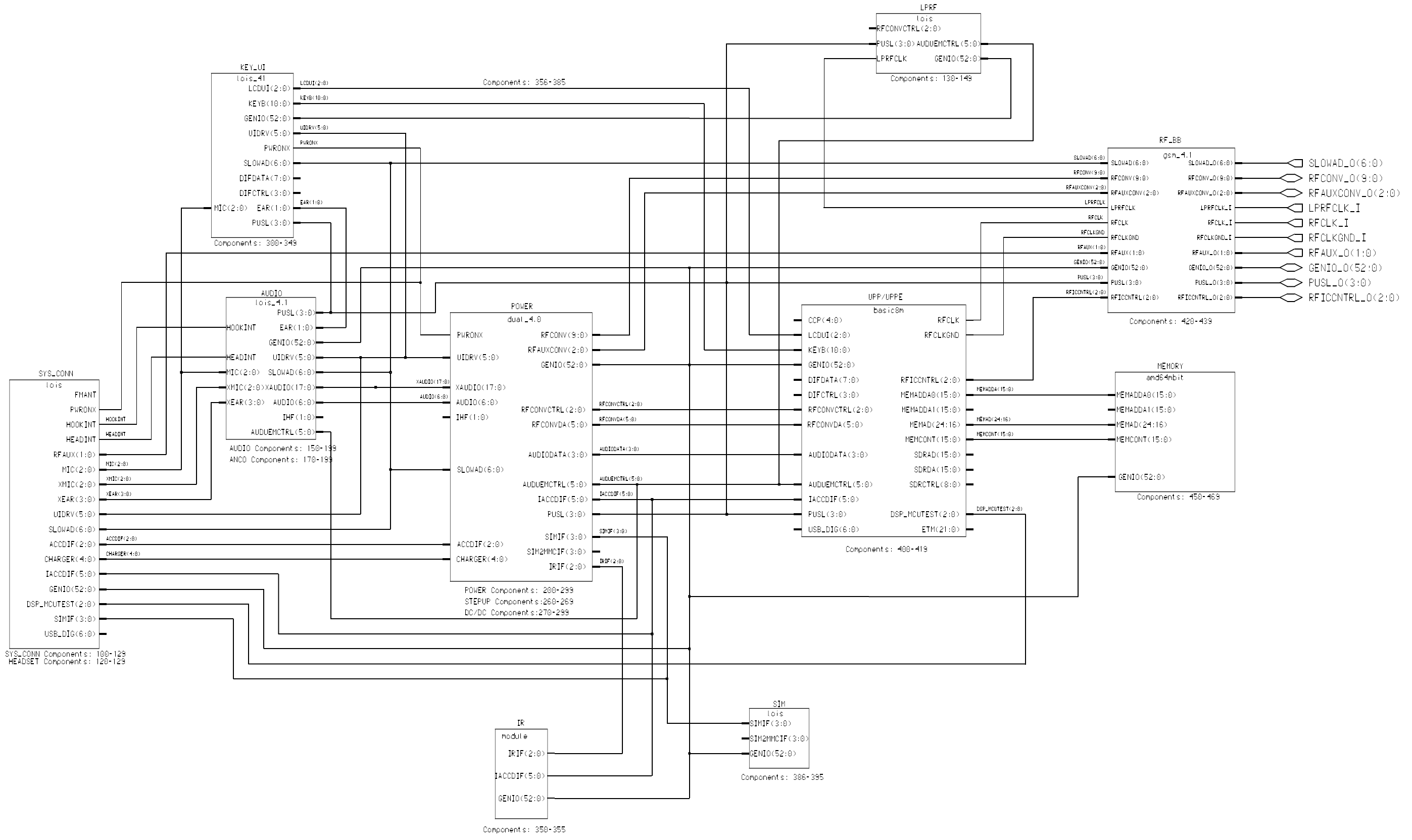

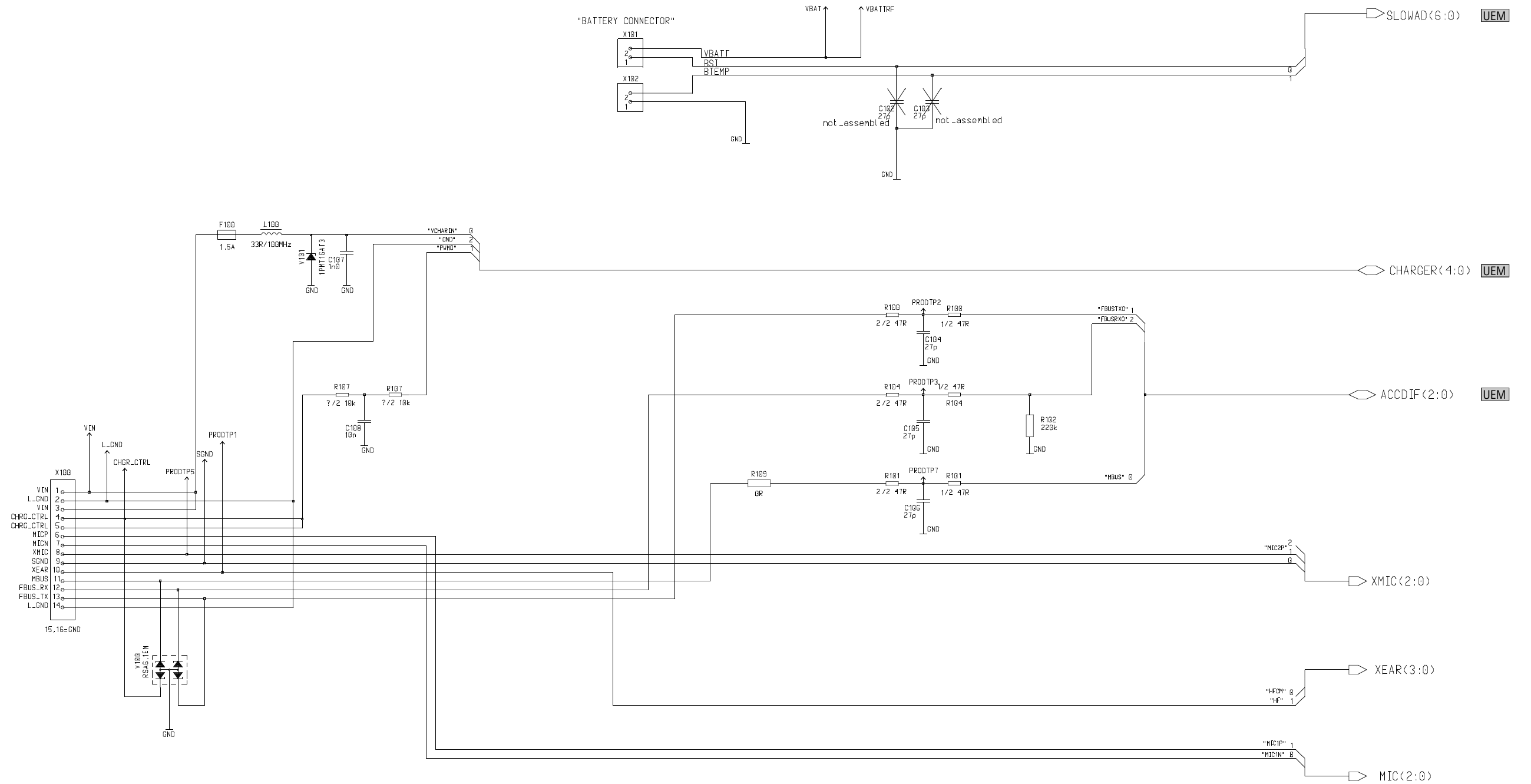

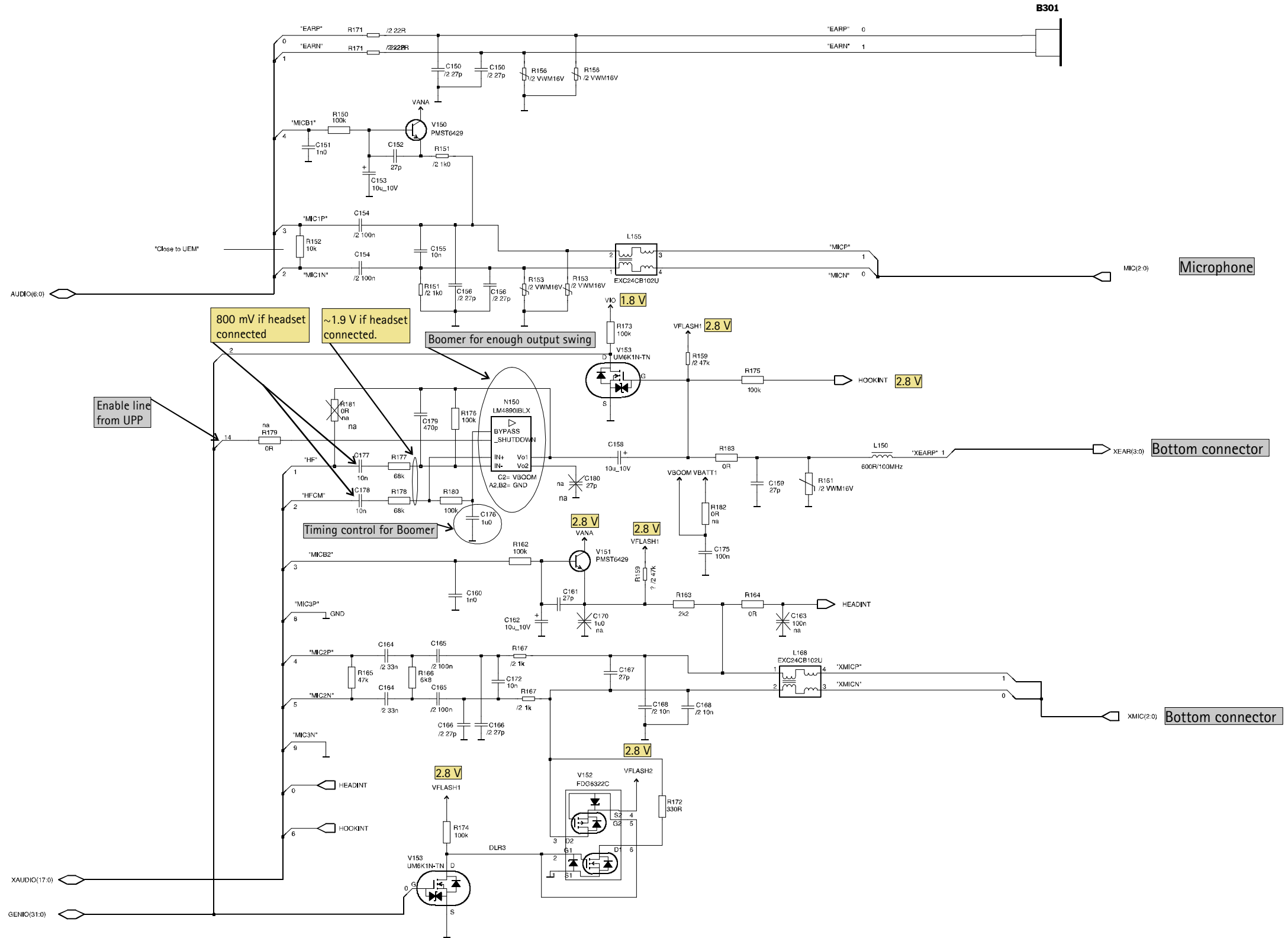

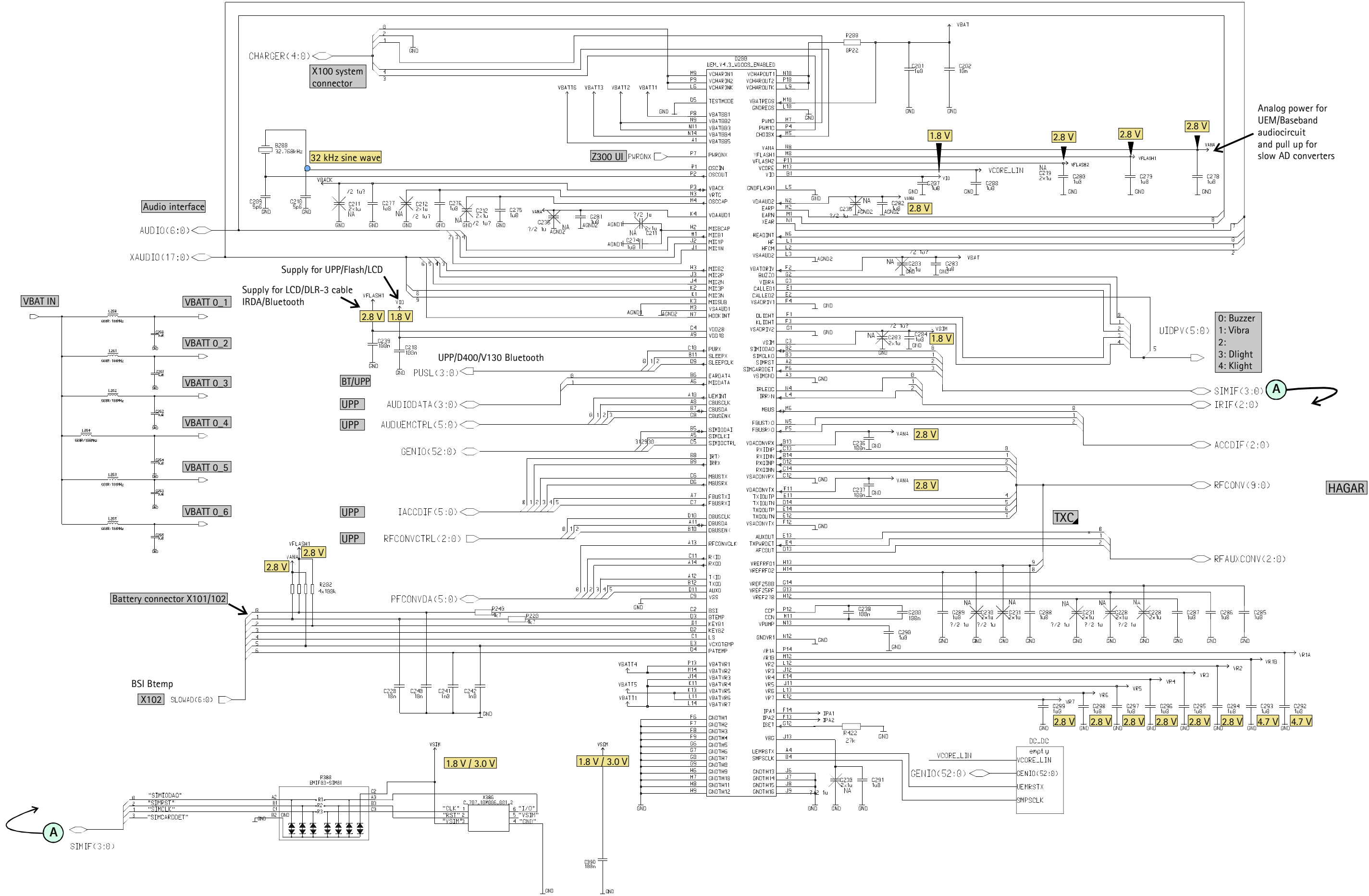

Analog power for UEM/Baseband audiocircuit and pull up for slow AD converters

- 0: Buzzer
- 1: Vibra
- 2:
- 3: Dlight
- 4: Klight

HAGAR

A

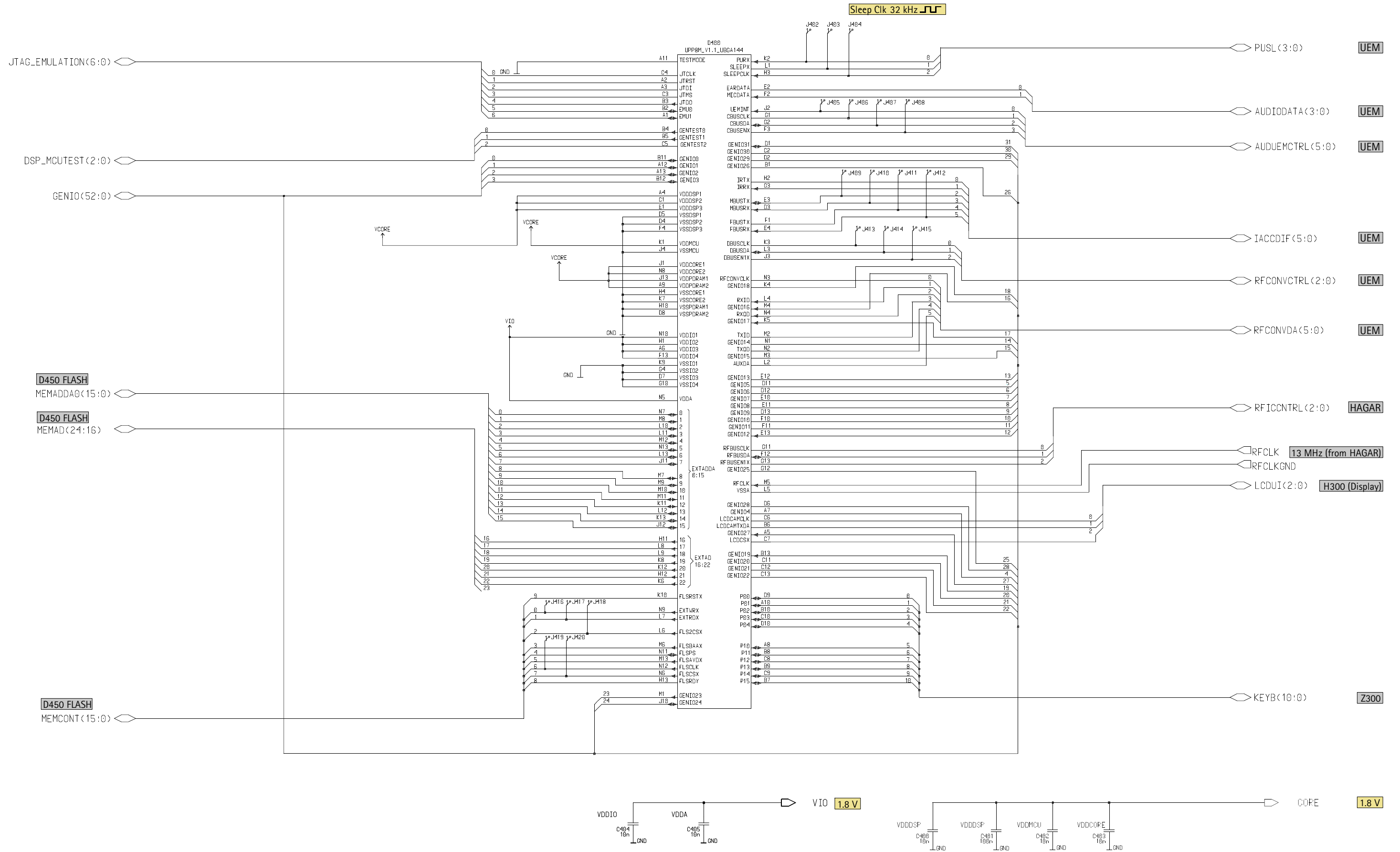

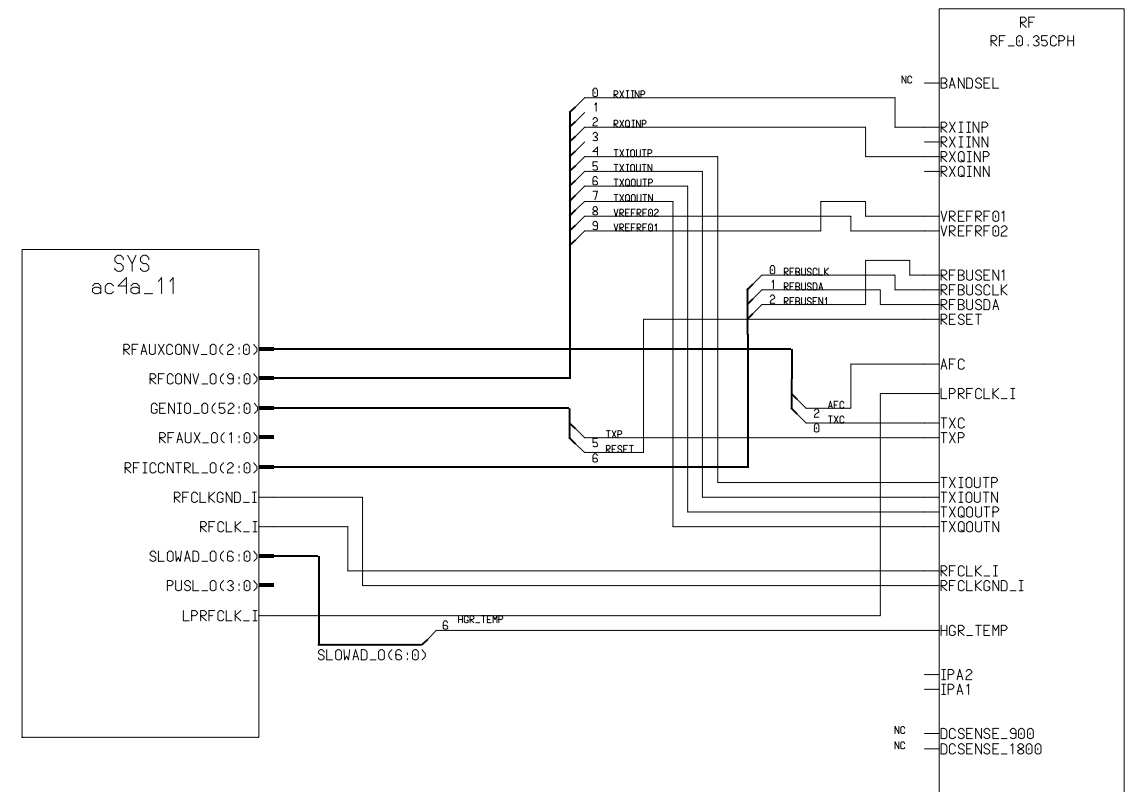
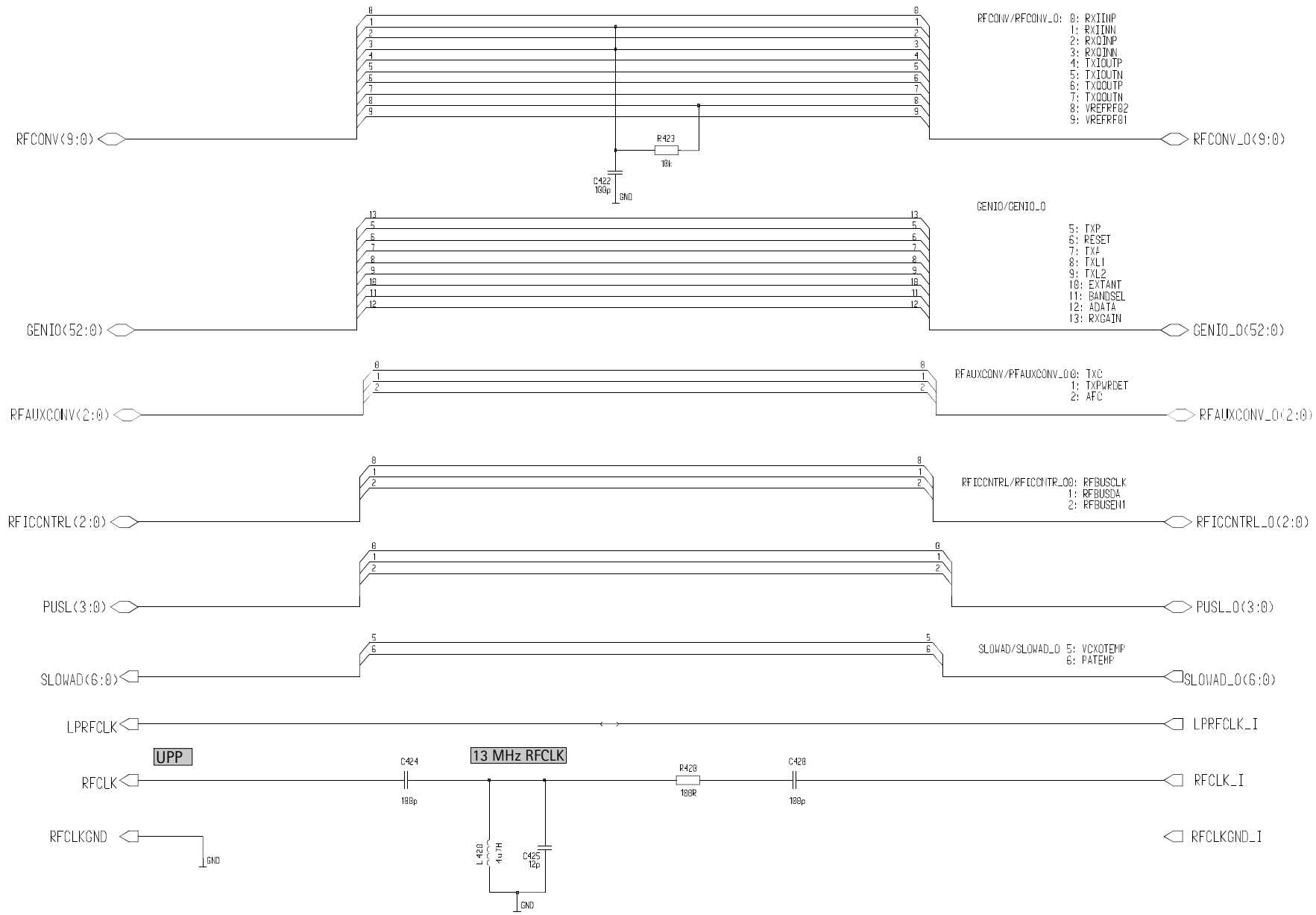

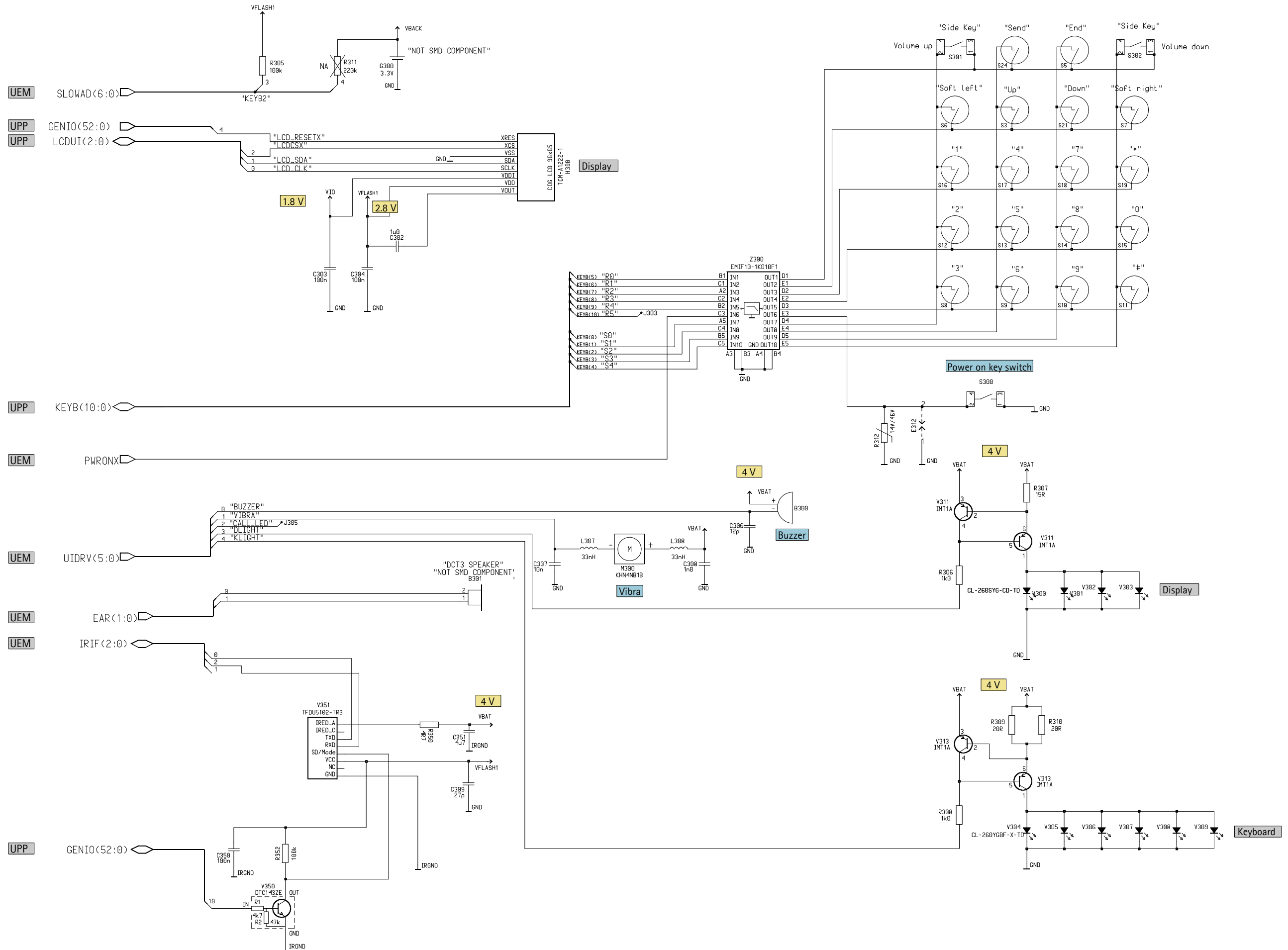

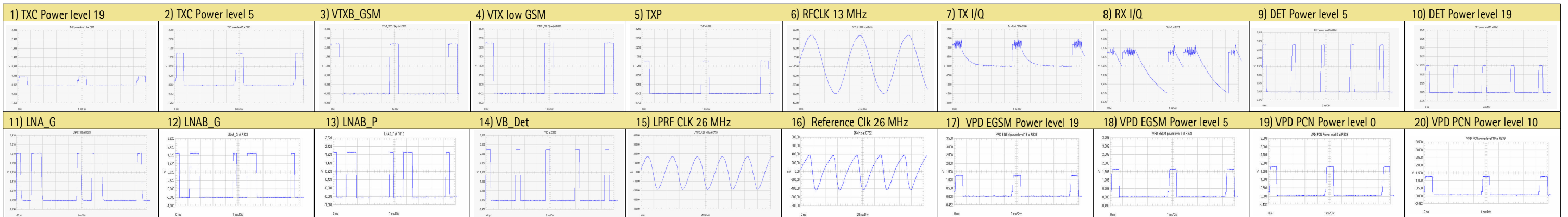
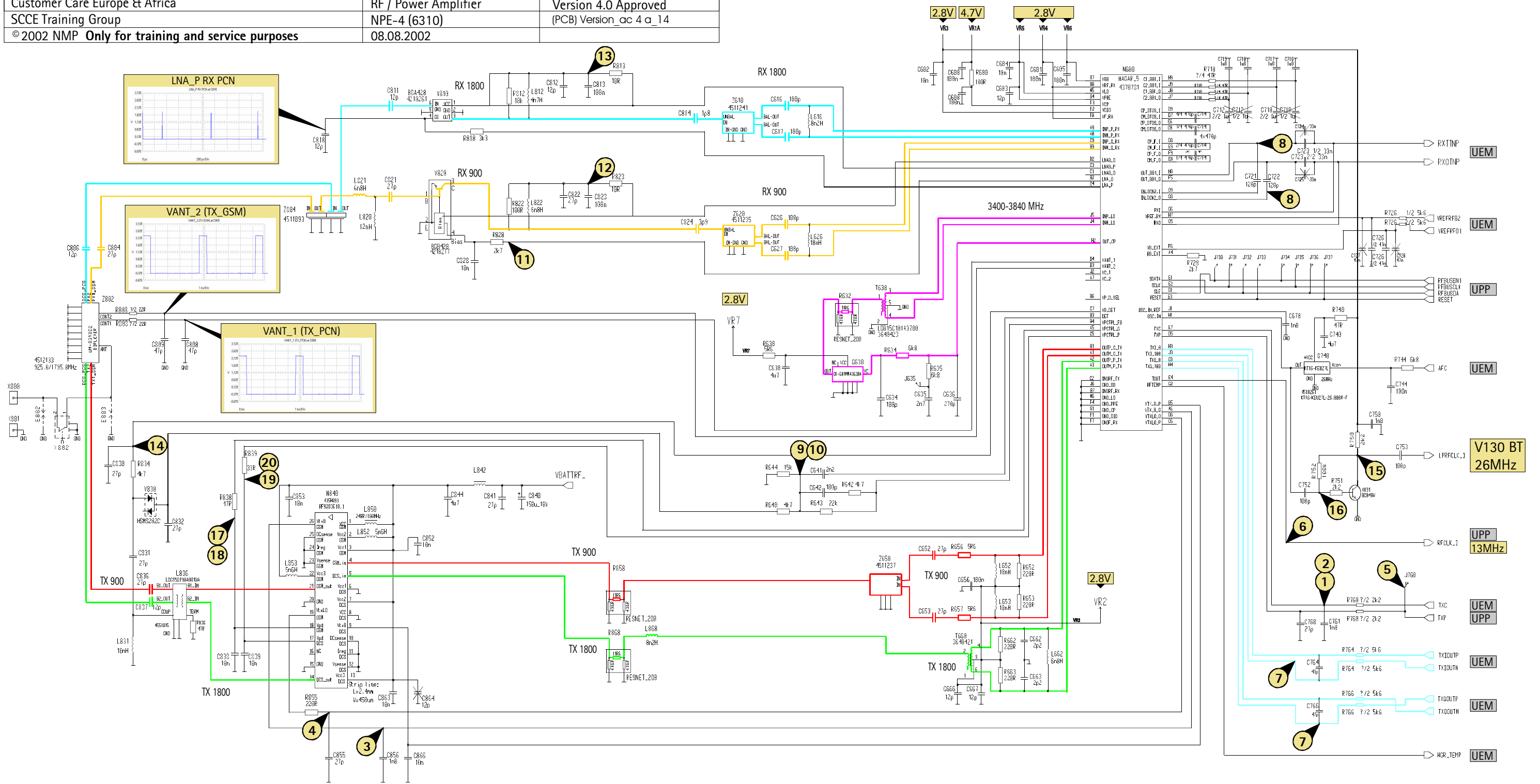

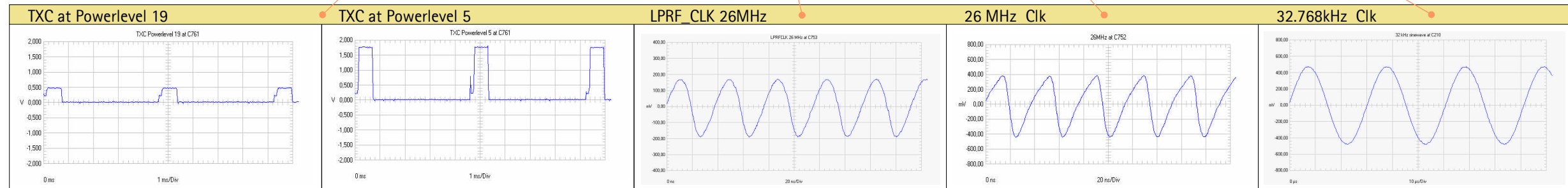
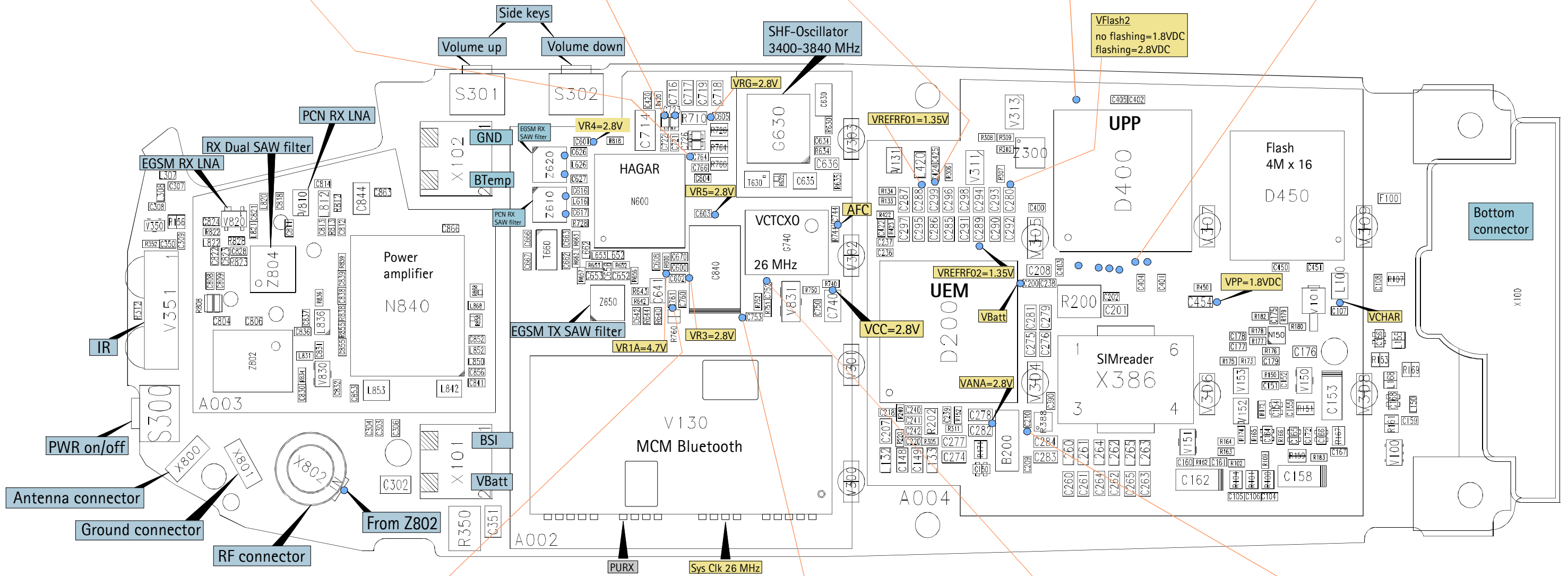
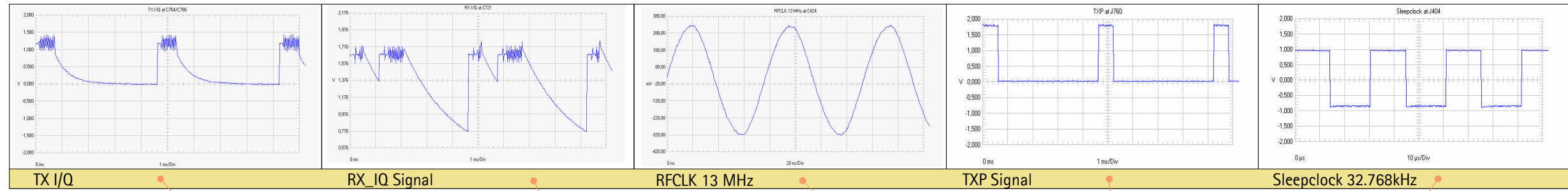

B	C161 - D6	C210 - C5	C279 - C5	C302 - D2	C450 - B6	C662 - B3	C760 - B3	C836 - C1	L100 - B6	L820 - B1	R133 - B4	R175 - C6	R352 - B1	R710 - A3	R855 - C2	V302 - B4	X800 - D1
B200	C164 - C6	C220 - D4	C281 - C5	C304 - C2	C454 - B6	C666 - B2	C764 - A3	C838 - B2	L132 - D4	L821 - B1	R134 - B4	R176 - C6	R388 - C5	R728 - B3	R858 - C2	V303 - A4	X801 - D1
C	C165 - C6	C390 - C5	C282 - B5	C306 - C2	C600 - B3	C667 - B2	C766 - A3	C839 - B2	L133 - D4	L831 - C1	R151 - C6	R178 - C6	R422 - B4	R740 - B4	S	V305 - B5	Z
C104 - D6	C166 - C6	C400 - B5	C283 - D5	C307 - B1	C601 - A3	C670 - B3	C804 - C1	C840 - B3	L150 - C7	L836 - C2	R152 - C5	R179 - C6	R423 - B4	R744 - B4	S300 - C1	V306 - C6	Z300 - A5
C105 - D6	C167 - D6	C238 - B5	C284 - D5	C308 - B1	C602 - B3	C714 - A3	C806 - C1	C841 - C2	L155 - C7	L842 - C2	R153 - C7	R180 - C6	R450 - B6	R750 - B4	S301 - A2	V307 - B6	Z610 - B3
C106 - D6	C168 - C7	C239 - C4	C285 - B5	C309 - B1	C603 - B3	C716 - A3	C808 - B1	C844 - B2	L168 - C7	L850 - C2	R156 - B1	R182 - C6	R600 - B3	R751 - C4	S302 - A3	V308 - C6	Z620 - A3
C107 - C6	C172 - C6	C240 - C4	C286 - B4	C312 - D2	C604 - B3	C717 - A3	C809 - B1	C852 - C2	L260 - D4	L852 - C2	R159 - D6	R183 - D6	R630 - A4	R752 - B4	T	V309 - B6	Z650 - B3
C108 - B7	C175 - C6	C241 - C4	C287 - B4	C350 - B1	C605 - A3	C718 - A3	C811 - B1	C853 - C2	L261 - D4	L853 - C2	R160 - D6	R200 - B5	R632 - B4	R760 - C3	T630 - B4	V311 - A5	Z802 - C1
C148 - D4	C176 - C6	C242 - C4	C288 - B4	C351 - D2	C608 - B3	C719 - A3	C812 - B2	C863 - B2	L262 - D4	L868 - B2	R161 - C7	R202 - C4	R634 - C1	R764 - A3	T660 - B3	V313 - A5	Z804 - B1
C149 - D4	C177 - C6	C260 - D5	C289 - B5	C616 - B3	C626 - A3	C721 - A3	C855 - C2	C866 - B2	L263 - D4	N	R162 - D6	R220 - C4	R635 - B4	R766 - A3	V	V350 - B1	
C150 - D5	C178 - C6	C261 - D5	C290 - B5	C617 - B3	C627 - B3	C813 - B2	C856 - C2	D	L264 - D4	N150 - C6	R163 - D6	R240 - C4	R640 - C3	R808 - B1	V100 - D7	V351 - C1	
C151 - C6	C179 - C6	C262 - D5	C291 - B5	C401 - B6	C630 - A4	C814 - B2	C818 - B1	D200 - C5	L307 - B1	N600 - B3	R164 - D6	R305 - D4	R642 - B2	R812 - B2	V101 - B6	V810 - B1	
C152 - C6	C200 - B5	C263 - D5	C292 - B5	C402 - A5	C634 - A4	C722 - A3	C821 - B1	D400 - B5	L308 - B1	N840 - B2	R165 - C6	R306 - A5	R643 - B3	R813 - B2	V130 - C3	V820 - B1	
C153 - C6	C201 - C5	C264 - D5	C293 - B5	C403 - B5	C635 - B4	C723 - A3	C822 - B1	D450 - B6	L420 - A4	R	R166 - C6	R307 - A5	R644 - C3	R818 - A3	V131 - A4	V830 - C1	
C154 - C6	C202 - C4	C265 - D5	C294 - B5	C404 - B5	C636 - A4	C726 - A3	C823 - B1	F	L616 - B3	R100 - D6	R167 - C6	R308 - A5	R652 - B3	R822 - B1	V150 - C6	V831 - B4	
C155 - C6	C236 - B4	C274 - D5	C295 - B4	C405 - A5	C641 - B3	C740 - B4	C824 - B1	F100 - B7	L626 - A3	R101 - D6	R169 - C7	R309 - A5	R653 - B3	R823 - B1	V151 - D6	X	
C156 - C7	C237 - B4	C275 - C5	C296 - B4	C420 - A3	C642 - C3	C744 - B4	C828 - B1	G	L652 - B3	R102 - D6	R171 - D5	R310 - A5	R656 - B3	R828 - B1	V152 - C6	X100 - B7	
C158 - D6	C207 - C4	C276 - C5	C297 - B4	C422 - B4	C652 - B3	C750 - C4	C830 - C1	G630 - A4	L653 - B3	R104 - D6	R172 - C6	R311 - C5	R657 - B3	R836 - B2	V153 - C6	X101 - D2	
C159 - C7	C208 - B5	C277 - D5	C298 - B5	C424 - A4	C653 - B3	C752 - B4	C831 - C1	G740 - B4	L662 - B3	R107 - B7	R173 - C6	R312 - C1	R662 - B3	R838 - C2	V300 - D4	X102 - A2	
C160 - D6	C209 - D5	C278 - C5	C299 - B4	C425 - A4	C656 - B3	C753 - C4	C832 - C2	L	L812 - B2	R109 - D6	R174 - C6	R350 - D2	R663 - B3	R839 - B2	V301 - C4	X386 - C5	

